



Mobil Plastic[®]

HO.RE.CA.

Catalogo
Generale
2022



CONTENITORI PER ALIMENTI E MILLEUSI

FOOD AND MULTIPURPOSE CONTAINERS

Pag. 6



CONTENITORI E TRASPORTO LIQUIDI

LIQUID STORAGE AND TRANSPORT

Pag. 24



ACCESSORI DA CUCINA E LAVORAZIONE ALIMENTI

**KITCHEN ACCESSORIES AND
FOOD PROCESSING**

Pag. 30



PULIZIA & RACCOLTA DIFFERENZIATA

CLEANING & WASTE COLLECTION

Pag. 42



DOVE SIAMO



Via Robbio 31,
27030 Confienza (PV)
ITALIA



Google Map



Apple Map



Shoot and go !



COME RAGGIUNGERCI

Mobil Plastic s.p.a. è ubicata in località CONFIENZA (PV) a ca. 15 km da Novara, Vercelli e Mortara.

In posizione strategica rispetto alle grandi linee di comunicazione, la si può raggiungere sia dalla A4 (Torino – Venezia) uscita Novara Est, che dalla A21 (Piacenza – Torino) uscita Voghera, che dalla A26 (Gravellona – Voltri) uscita Vercelli Est.

HOW TO REACH US

Mobil Plastic s.p.a. is located in CONFIENZA (PV) about 15 km from Novara, Vercelli and Mortara.

In a strategic position with respect to the main transport network, it can be reached either from the A4 (Turin-Venice) Novara Est exit or from the A21 (Piacenza-Turin) Voghera exit or from the A26 (Gravellona-Voltri) Vercelli Est exit.



Venezia

Bologna

ROMA

About



1968

Verso la fine degli anni '60, gli anni che hanno segnato la storia industriale dell'Italia, e più precisamente nel 1968, viene fondata l'azienda Mobil Plastic.

Fin dai primi anni il successo è stato immediato, prima in Italia, per poi espandersi nei principali mercati europei di riferimento con la presenza a tutte le Fiere Internazionali più importanti del settore.

In the late '60s and more precisely in 1968, years that marked the industrial history in Italy, Mobil Plastic started its activity.

Since the early years, the company has made an instant success, first of all in Italy and then also in the most important European markets, attending all the best known international exhibitions in its sector.

1997

Nel pieno della sua continua espansione, nel 1997 avviene il passaggio generazionale alla guida della società. Subentrano infatti i figli del fondatore, Alberto e Pierangelo, i quali fin da subito pongono le basi per una ulteriore crescita applicando una rinnovata politica aziendale unitamente a moderne strategie commerciali.

Nuove ed innovative tecnologie di produzione ed una attenta e mirata ricerca e diversificazione, consentono, pochi anni dopo, l'apertura di una nuova unità produttiva all'estero.

In 1997, in the middle of its continuous expansion, the company generational handover took place.

The founder's sons, Alberto and Pierangelo, chose to follow an updated company policy together with new business strategies. Few years later, thanks to new production technologies, a focused research and diversification approaches, Mobil Plastic started a new production unit abroad.

.....to be continued

50^o

Anni di storia



2008

Il 2008 segna una ulteriore ed importante svolta con l'acquisizione di una storica azienda Italiana molto conosciuta con il marchio SSS, attiva da oltre 40 anni nel settore casalingo, enologico, industriale e più di recente anche nel settore ecologico.

L'importante investimento vede raddoppiare le dimensioni aziendali e i volumi di produzione imponendo alla società Mobil Plastic nuovi obiettivi, nuove strategie e nuove sfide commerciali.

2008 marks a further important turning point thanks to the takeover of a well-known Italian company famous for the "SSS" brand, which has been working for more than 40 years in the enology, households, industrial and, more recently, eco-friendly sector.

This important investment doubles the company dimensions and the production volumes, imposing to Mobil Plastic new goals, new strategies and new business challenges.

2018

Mobil Plastic compie 50 anni ed è sempre più una realtà leader nel suo settore merceologico.

E' affermata in tutta Europa con lo spirito dell'innovazione, di nuovi processi produttivi, del web e dei nuovi mercati; si apre una nuova era e nasce la nuova immagine della società in linea con i tempi. Ancora una volta, Mobil Plastic pone le basi per una ulteriore evoluzione e crescita e si propone al mercato come "partner" serio, affidabile e moderno

Mobil Plastic celebrates 50 years of activity and nowadays it is a leading company on its market. It is a well-known company all over Europe thanks to its spirit of innovation, its tendency for new production processes, web market and other sectors. This is the beginning of a new era with a contemporary and up-to-date corporate image.

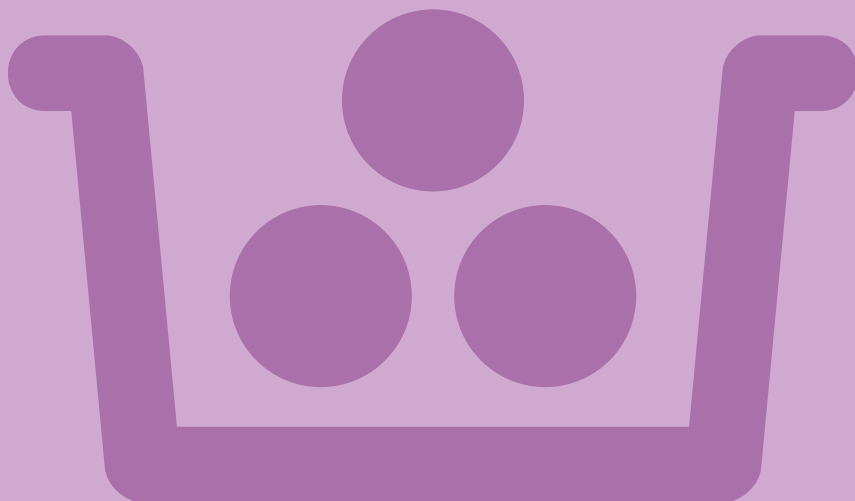

CONTENITORI PER ALIMENTI E MILLEUSI

Food and Multipurpose Containers

pag. 8 art. 4400 art. 4407

pag. 9 art. 4410 art. 4413

pag. 10 art. 5800 art. 6007

pag. 11 art. 6010 art. 6013

pag. 13 art. 5908 art. 5911 art. 5900

pag. 14 art. 131 art. 132 art. 133

pag. 15 art. 143

pag. 16 art. 42 art. 39

pag. 17 art. 41 art. 47 art. 82

pag. 18 art. 19 art. 59

pag. 19 art. 19 art. 59

pag. 20 art. 18

pag. 21 art. 19/1

pag. 22 art. 17 art. 20/1 art. 150

pag. 23 art. 7 art. 59

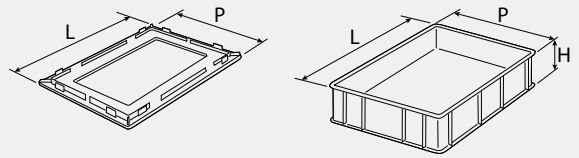

4400	L 60	P 40		
4407	L 60	P 40	H 7	l 12
4410	L 60	P 40	H 10	l 18
4413	L 60	P 40	H 13	l 24

CONTENITORI PER ALIMENTI E MILLEUSI

Food and Multipurpose Containers



impilabili



temperatura
esercizio

4400
Coperchio per casse
Lid for crate



Fondo liscio
Smooth bottom



4407
Cassa impilabile fondo chiuso e pareti chiuse
Stackable crate full bottom and walls



Cassa impilabile fondo chiuso e pareti chiuse

Stackable crate full bottom and walls



4410

Cassa impilabile fondo chiuso e pareti chiuse
Stackable crate full bottom and walls



Fondo liscio
Smooth bottom



4413

Cassa impilabile fondo chiuso e pareti chiuse
Stackable crate full bottom and walls



Fondo liscio
Smooth bottom



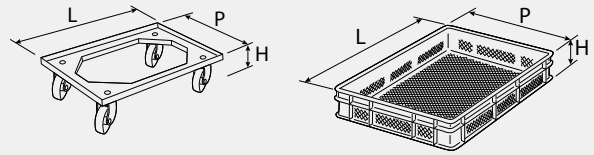

5800	L 62	P 42	H 14	
6007	L 60	P 40	H 7	l 12
6010	L 60	P 40	H 10	l 18
6013	L 60	P 40	H 13	l 24

CONTENITORI PER ALIMENTI E MILLEUSI

Food and Multipurpose Containers



5800

Carrello per cassetta 60x40 cm
Trolley 60x40 cm for crate



impilabili



temperatura esercizio



ROB



Fondo grigliato
Grilled bottom



6007

Cassa impilabile fondo forato e pareti forate
Stackable crate perforated bottom and perforated walls



N



Cassa impilabile fondo forato e pareti forate

Stackable crate perforated bottom and perforated walls



6010

Cassa impilabile fondo forato e pareti forate
Stackable crate perforated bottom and perforated walls



Fondo grigliato
Grilled bottom



6013

Cassa impilabile fondo forato e pareti forate
Stackable crate perforated bottom and perforated walls



Fondo grigliato
Grilled bottom





CONTENITORI PER ALIMENTI E MILLEUSI

Food and Multipurpose Containers

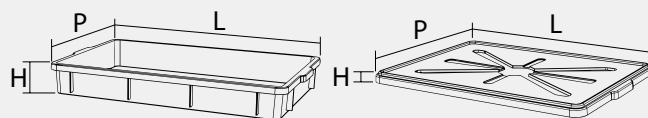

art.	L x P x H Esterne External	L x P x H Interne Internal	Capacità Capacity
5900	655 x 435 x 30	-	-
5908	650 x 425 x 85	600 x 400 x 80	19 l
5911	650 x 425 x 115	600 x 400 x 110	25 l



impilabili



temperatura
esercizio

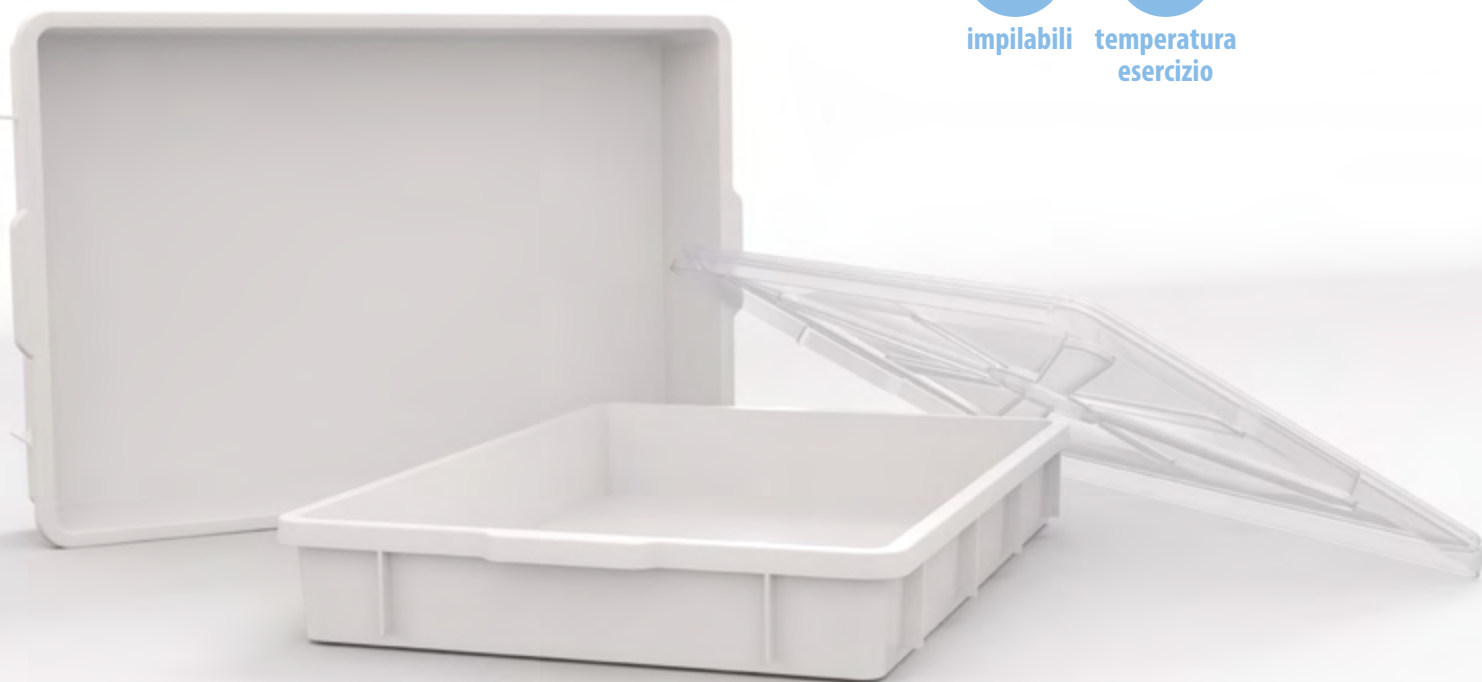

Cassa LIGHT BOX

Stackable LIGHT BOX



5908

Cassa chiusa impilabile con maniglie - 19 l
Stackable crate full bottom and walls with handles - 19 l



5911

Cassa chiusa impilabile con maniglie - 25 l
Stackable crate full bottom and walls with handles - 25 l



5900

Coperchio per casse LIGHT BOX
Lid for LIGHT BOX crate





CONTENITORI PER ALIMENTI E MILLEUSI

Food and Multipurpose Containers

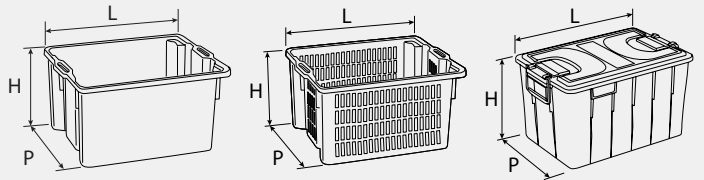

131/50	L 55 cm	P 43 cm	H 31 cm	l 50
131/65	L 63 cm	P 44 cm	H 34 cm	l 65
131/90	L 72 cm	P 47 cm	H 36 cm	l 90
132/50	L 55 cm	P 43 cm	H 31 cm	l 50
132/65	L 63 cm	P 44 cm	H 34 cm	l 65
143/20	L 38 cm	P 28 cm	H 30 cm	l 20
143/40	L 58 cm	P 38 cm	H 26 cm	l 40
143/60	L 58 cm	P 38 cm	H 38 cm	l 60



impilabili



temperatura
esercizio



133
Coperchio per cassa
Lid for crate



131
Cassa milleusi impilabile sovrapponibile
Stackable and insertable multipurpose crates



132
Cassa forata impilabile sovrapponibile
Stackable and insertable perforated crates



Cassa milleusi sovrapponibile ed impilabile

Stackable and insertable multipurpose crates



143

Cassa universale con coperchio (per alimenti)
Crate with lid (for food)



Coperchi impilabili
Stackable lids



Porta targhetta
Tag holder



Casse grandi e piccole tra loro
sovrapponibili
*Large and small crates can be put
one on the other*





CONTENITORI PER ALIMENTI E MILLEUSI

Food and Multipurpose Containers

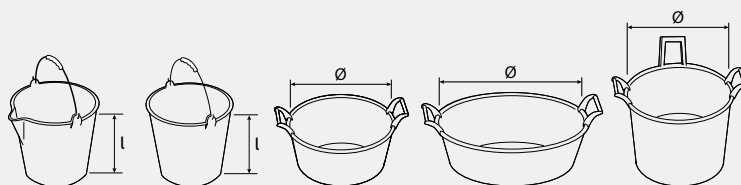

42	l9	l12	l15				
39	l7	l9	l12	l15			
41	Ø 32 cm	Ø 34 cm	Ø 36 cm	Ø 40 cm	Ø 45 cm	Ø 50 cm	
47	Ø 45 cm	Ø 50 cm	Ø 55 cm	Ø 60 cm	Ø 65 cm	Ø 70 cm	Ø 80 cm
82	Ø 45 cm	Ø 50 cm	Ø 55 cm	Ø 60 cm	Ø 65 cm	Ø 70 cm	



42

Secchio con becco graduato
Graduated bucket with pouring lip



39

Secchio graduato
Graduated bucket





41
Bagno Tondo
Round Basin

○
N



47
Bagno ovale
Oval basin

○
N



art. 82
Mastello 3 manici
3-handle tub

○
N





CONTENITORI PER ALIMENTI E MILLEUSI

Food and Multipurpose Containers

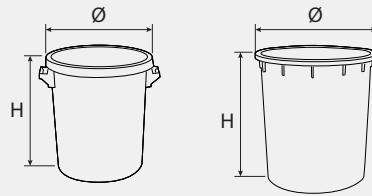

19/35	Ø 39 cm	H 41 cm	l 35
19/50	Ø 45 cm	H 47 cm	l 50
19/75	Ø 49 cm	H 57 cm	l 75
19/100	Ø 52 cm	H 67 cm	l 100
19/150	Ø 61 cm	H 70 cm	l 150
19/200	Ø 67 cm	H 80 cm	l 200
19/300	Ø 78 cm	H 88 cm	l 300



PP 59/035



PP 59/050



PP 59/075



PP 59/100

59

Coperchio dotato di maniglia
Lid equipped with handle



19/035



19/050



19/075



19/100

19

Bidone industriale con manici
Industrial bin with handles



Bidone industriale

Industrial bin



 **59/150**



 **59/200**



 **59/300**

59
Coperchio
Lid



19/150



19/200



19/300

19
Bidone industriale senza manici
Industrial bin without handles





**CONTENITORI PER
ALIMENTI E MILLEUSI**
Food and Multipurpose
Containers

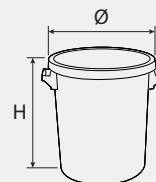

18/075	Ø 48 cm	H 57 cm	l 75
18/100	Ø 52 cm	H 67 cm	l 100



18

Contenitore con chiusura ad anello in metallo completo di guarnizione
Chiusura non a tenuta stagna.

*Metal ring closure bin complete of gasket.
Non-watertight*



Carrello per bidone industriale

Industrial bin trolley

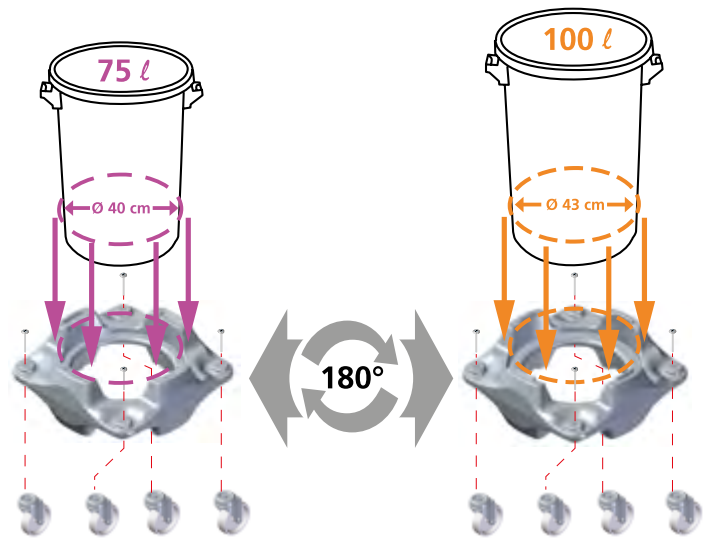

A seconda del lato in cui vengono montate le ruote è adatto al trasporto di bidoni da 75 litri o da 100 litri.

You can fit the wheels in both sizes, one size is suitable for the 75 litres industrial bin and one for the 100 litres bin.

Il carrello per bidone industriale ha una robusta struttura in polipropilene e 4 ruote piroettanti di cui due dotate di meccanismo di bloccaggio.

The trolley for industrial bins is made of a solid structure in polypropylene. It has 4 turning somersault wheels, two of them have a blocking mechanism.



Il carrello può essere impilato (anche con ruote già montate) in 2 modi diversi a seconda delle necessità.

The trolley is stackable (you can overlap it one another even when the wheels already placed) in two different ways, as far as you need it.



19/1

Carrello per bidone industriale
Trolley for industrial bin





CONTENITORI PER ALIMENTI E MILLEUSI

Food and Multipurpose Containers

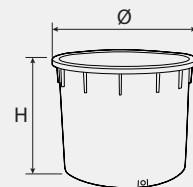

7/0110	Ø 80 cm	H 30 cm	l 110
7/0275	Ø 110 cm	H 35 cm	l 275
7/0225	Ø 86 cm	H 54 cm	l 225
7/0350	Ø 95 cm	H 71 cm	l 350
7/0500	Ø 104 cm	H 82 cm	l 500
7/0700	Ø 115 cm	H 90 cm	l 700
7/1000	Ø 134 cm	H 95 cm	l 1000

17

Filtro svinarola per rubinetto 1"

Wine filter 1" tap



20/ 1

Rubinetto 1"

Tap 1"



150

Maniglia per mastello

Handle for tub





59/500



59/700

59
Coperchio
Lid



7/0110



7/0275



7/0225



7/0350



7/0500



7/0700



7/1000

7
Mastello
Tub



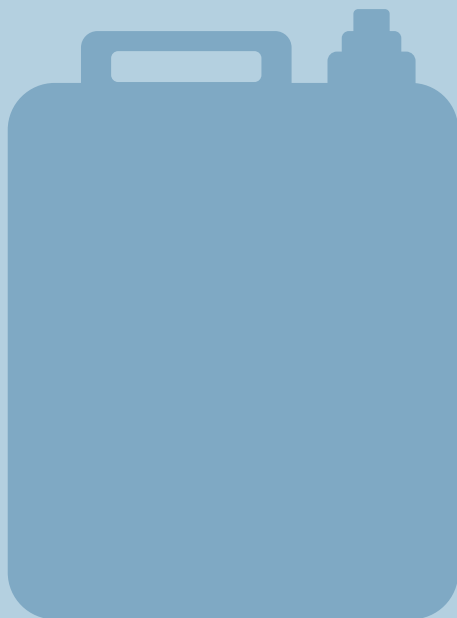

CONTENITORE TRASPORTO LIQUIDI

Liquid Storage and Transport

pag. 26 art. 78

pag. 27 art. 97 art. 20/1/4

pag. 28 art. 61

pag. 29 art. 125 art. 73



CONTENITORI E TRASPORTO LIQUIDI

Liquid Storage and
Transport

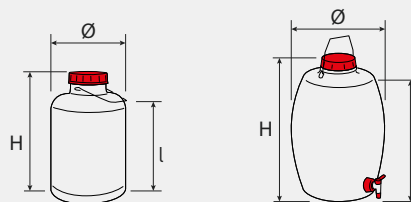

78/02	Ø 14 cm	H 21 cm	l 2	B Ø 10 cm
78/05	Ø 16 cm	H 31 cm	l 5	B Ø 10 cm
78/10	Ø 21,5 cm	H 35,5 cm	l 10	B Ø 11 cm
97/005	Ø 18 cm	H 28 cm	l 5	
97/010	Ø 23 cm	H 32 cm	l 10	
97/015	Ø 27 cm	H 37 cm	l 15	
97/020	Ø 29 cm	H 41 cm	l 20	
97/025	Ø 32 cm	H 44 cm	l 25	
97/050	Ø 39 cm	H 56 cm	l 50	
97/100	Ø 40 cm	H 71 cm	l 100	



78/02



78/05



78/10

78
Bidone collo largo
Wide neck can



Bidone collo largo - fustino a botticella

Wide neck can - Small barrel

ACCESSORI
ACCESSORIES
20/1/4
Rubinetto 1/4"
Tap 1/4"



particolare



97/005



97/010



97/015



97/020



97/025



97/050



97/100

97

Fustino a botticella dotato di rubinetto e tappo
Small barrel with tap and cap





CONTENITORI E TRASPORTO LIQUIDI

Liquid Storage and
Transport

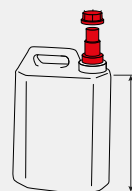

61	l 15-3,5
125/01	l 1
125/02	l 2
125/03	l 3
125/05	l 5
*125/10	l 10
*125/15	l 15
*125/20	l 20
*125/25	l 25
*125/30	l 30
73/10	l 10
73/20	l 20



- * Versatore telescopico incluso
- * Telescopic pourer included

Tanica due usi
Double use tank



61



Tanica Tank



125/01



125/02



125/03



125/05



125/10



125/15



125/20



125/25



125/30

Tanica con rubinetto Tank with tap



73/10



73/20



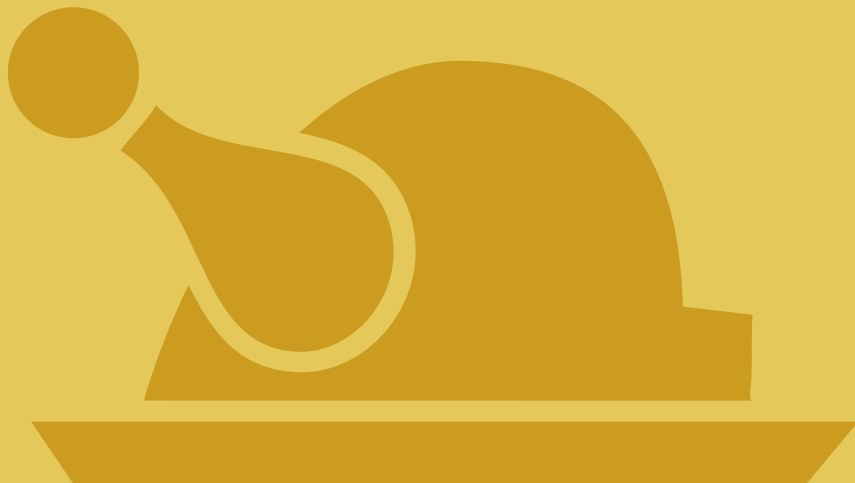

ACCESSORI DA CUCINA E LAVORAZIONE ALIMENTI

Kitchen accessories and food processing

pag. 32 art. 9 art. 96

pag. 33 art. 142 art. 149

pag. 34 art. 6

pag. 35 art. 54 art. 43 art. 147

pag. 36 art. 35 art. 10/26

pag. 37 art. 12 art. 109 art. 50

pag. 38 art. 128 art. 148

pag. 39 art. 130

pag. 40 art. 31 art. 136

pag. 41 art. 86 art. 86/1



ACCESSORI DA CUCINA E LAVORAZIONE ALIMENTI

Kitchen accessories and food processing

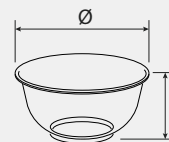

9/13	Ø 13 cm	l 0,4
9/17	Ø 17 cm	l 1,0
9/23	Ø 23 cm	l 2,5
9/28	Ø 28 cm	l 4,0
9/32	Ø 32 cm	l 8,0
9/38	Ø 38 cm	l 10,0
96/13	Ø 13 cm	l 0,4
96/17	Ø 17 cm	l 1,0
96/23	Ø 23 cm	l 2,5
96/28	Ø 28 cm	l 4,0
96/32	Ø 32 cm	l 8,0
96/38	Ø 38 cm	l 10,0



9
Bol in polipropilene
Polypropylene bowl



○
BIM

La forma semisferica permette un'omogenea miscelazione manuale degli ingredienti. L'assenza di spigoli agevola la pulizia del prodotto.

Its semispherical shape helps a homogeneous manual mixing of ingredients. It is easy to clean because it lacks of angles.



Il bordo superiore, grazie alla sua particolare geometria, dà rigidità a tutto il corpo della bowl e funziona da "salvagoccia".

The superior edge, thanks to its particular shape, gives rigidity to the to the body of the bowl, so that it works as "drop-saver".



96
Bol in policarbonato
Polycarbonate bowl



○
TS

Bol - Contenitori Gastronorm

Bowl - Containers Gastronorm

141

Falso fondo GASTRONORM
Grilled bottom GASTRONORM

142

Contenitori GASTRONORM
Containers GASTRONORM

149

Coperchi GASTRONORM
Lids GASTRONORM



	MOD.	COD.	SPES.	H	l
	1/1	142/1/1/200-PP	2,9 mm	200 mm	26,4 l
		142/1/1/150-PP	2,8 mm	150 mm	20,0 l
		142/1/1/100-PP	2,6 mm	100 mm	13,3 l
		142/1/1/065-PP	2,5 mm	65 mm	9,0
		149/1/1-PP	2,4 mm	—	—
		141/1/1-PP	2,7 mm	—	—
	1/2	142/1/2/200-PP	2,5 mm	200 mm	11,9 l
		142/1/2/150-PP	2,5 mm	150 mm	9,0 l
		142/1/2/100-PP	2,5 mm	100 mm	6,1 l
		142/1/2/065-PP	2,5 mm	65 mm	4,0 l
		149/1/2-PP	1,75 mm	—	—
		141/1/2-PP	2,7 mm	—	—
	1/3	142/1/3/200-PP	2,65 mm	200 mm	7,1 l
		142/1/3/150-PP	2,6 mm	150 mm	5,5 l
		142/1/3/100-PP	2,55 mm	100 mm	3,8 l
		142/1/3/065-PP	2,5 mm	65 mm	2,5 l
		149/1/3-PP	1,65 mm	—	—
		141/1/3-PP	2,5 mm	—	—

	MOD.	COD.	SPES.	H	l
	1/4	142/1/4/200-PP	2,6 mm	200 mm	4,8 l
		142/1/4/150-PP	2,5 mm	150 mm	3,8 l
		142/1/4/100-PP	2,3 mm	100 mm	2,6 l
		142/1/4/065-PP	2,3 mm	65 mm	1,7 l
		149/1/4-PP	1,6 mm	—	—
			1/6	142/1/6/200-PP	2,6 mm
142/1/6/150-PP	2,5 mm			150 mm	2,3 l
142/1/6/100-PP	2,4 mm			100 mm	1,6 l
142/1/6/0,65-PP	2,3 mm			0,65 mm	1,0 l
149/1/6-PP	1,4 mm			—	—
141/1/6-PP	2,5 mm			—	—
	1/9	142/1/9/100-PP	1,9 mm	100 mm	0,9 l
		142/1/9/065-PP	1,9 mm	0,65 mm	0,6 l
		149/1/9-PP	1,5 mm	—	—

Gli articoli in polipropilene non rientrano nella normativa Gastronorm EN 631, in quanto il naturale ritiro termico del materiale fa sì che le misure perimetrali siano fuori dalle tolleranze della normativa, anche se di soli 2-3 mm.

The articles in polycarbonate are not included in the Gastronorm EN 631 regulations, since, according to the tolerances of the regulations, the natural thermal shrinkage of the material do not respect the external sizes, even if only of 2-3 mm.





**ACCESSORI DA CUCINA E
LAVORAZIONE ALIMENTI**
Kitchen accessories and
food processing



6/0500	l 0,5
6/1000	l 1
6/2000	l 2
6/3000	l 3
6/5000	l 5



Caraffa graduata
Graduated jug



6/0500



6/1000



6/2000



6/3000



6/5000



BIM



TS



Caraffa graduata - Imbuto

Graduated jug - Funnel

Imbuto Funnel



54

Ø 6 - 8 - 10 - 12 - 14 - 16 - 18 - 20 - 22 - 24 - 26 - 30 cm



Imbuto con porta filtro Funnel with filter-support



43

Ø 22 - 26 - 30 - 35 cm



ART. 147/10

Filtro Ø 10 cm
per imbuto Ø 22 cm
+ Retina in acciaio inox
Maglia 0,35 mm
Filter Ø 10 cm
for funnel Ø 22 cm
+ stainless steel mesh 0,35 mm



ART. 147/12

Filtro Ø 12 cm.
per imbuto Ø 26 - 30 - 35 cm
+ Retina in acciaio inox
Maglia 0,35 mm
Filter Ø 12 cm
for funnel Ø 26 - 30 - 35 cm
+ stainless steel mesh 0,35 mm





ACCESSORI DA CUCINA E LAVORAZIONE ALIMENTI

Kitchen accessories and food processing

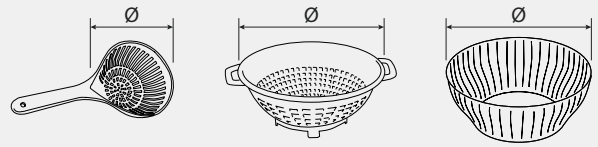

12	Ø 18 cm
109/22	Ø 22 cm
109/26	Ø 26 cm
109/30	Ø 30 cm
50/16	Ø 16 cm
50/18	Ø 18 cm
50/20	Ø 20 cm
50/22	Ø 22 cm
50/24	Ø 24 cm
50/26	Ø 26 cm
50/28	Ø 28 cm
50/30	Ø 30 cm
50/32	Ø 32 cm
50/34	Ø 34 cm



35

Ø 27 cm Colalatte con filtro (Ø 10 cm)
Ø 27 cm Milk colander with strainer (Ø 10 cm)



10/26

Ø 26 cm Imbuto (PP) con tubo (PEHD) flessibile e filtro
Ø 26 cm Funnel (PP) with flexible tube (PEHD) and filter



Scolapasta - Insalatiere

Pasta colander - Salad bowl



12

Scolapasta con manico 39 cm
Pasta-strainer with handle 39 cm



109/22

109/26



109/30



109
Scolapasta
Pasta colander



50/16

50/18

50/20

50/22

50/24

50/26



50/28

50/30

50/32

50/34

50
Insalatiera
Salad bowl





VASSOI con bordo alto 5 cm realizzati in PMMA (metacrilato antiassorbente), adatti alla presentazione di alimenti. Disponibili in 2 colori (bianco e nero) in 5 misure.

High edge trays in PMMA 5 cm (non-absorbing methacrylate), suitable for food display. Available in 2 colours (black and white) and 5 sizes.



ACCESSORI DA CUCINA E LAVORAZIONE ALIMENTI

Kitchen accessories and food processing

ART. 128	L mm	H mm	P mm
128/A3-BIM	220	50	440
128/A3-NER	220	50	440
128/A4-BIM	220	50	295
128/A4-NER	220	50	295
128/A5-BIM	290	50	440
128/A5-NER	290	50	440
128/A6-BIM	220	50	220
128/A6-NER	220	50	220
128/A7-BIM	220	50	360
128/A7-NER	220	50	360

128 Vassoi Trays



BIM



NER



VASSOI con bordo basso realizzati in SAN (antiassorbente), adatti alla presentazione di alimenti. Disponibili in 2 colori (bianco e nero) in 5 misure.

Low edge trays in SAN (anti-absorbent), suitable for food display. Available in 2 colours (black and white) and 5 sizes.



ART. 148	L mm	H mm	P mm
148/20-BIM	200	12	150
148/20-NER	200	12	150
148/28-BIM	280	12	190
148/28-NER	280	12	190
148/35-BIM	350	12	240
148/35-NER	350	12	240
148/42-BIM	420	12	300
148/42-NER	420	12	300
148/50-BIM	500	12	360
148/50-NER	500	12	360

148 Vassoi Trays



BIM



NER



VASSOI con bordo alto 3,5 cm realizzati in PMMA (metacrilato antiassorbente), adatti alla presentazione di alimenti. Disponibili in 2 colori (bianco e nero) in 5 misure.

High edge trays in PMMA 3,5 cm (non-absorbing methacrylate), suitable for food display. Available in 2 colours (black and white) and 5 sizes.



130
Vassoi
Trays



BIM



NER

ART. 130	L mm	H mm	P mm
130/A3-BIM	220	35	440
130/A3-NER	220	35	440
130/A4-BIM	220	35	295
130/A4-NER	220	35	295
130/A5-BIM	290	35	440
130/A5-NER	290	35	440
130/A6-BIM	220	35	220
130/A6-NER	220	35	220
130/A7-BIM	220	35	360
130/A7-NER	220	35	360



Esempi abbinamenti per 128 - 130

Con i vassoi della nuova linea a bordo alto (3,5 - 5 cm), oltre ad avere un maggior spessore, si possono realizzare abbinamenti tra le varie misure e altezze (vedi disegni con alcune possibilità).

The brand new range of display trays, high sided (3,5 - 5 cm) and thicker, thanks to their new dimensions allow to suit a standard surface by different displays and heights (see examples below).

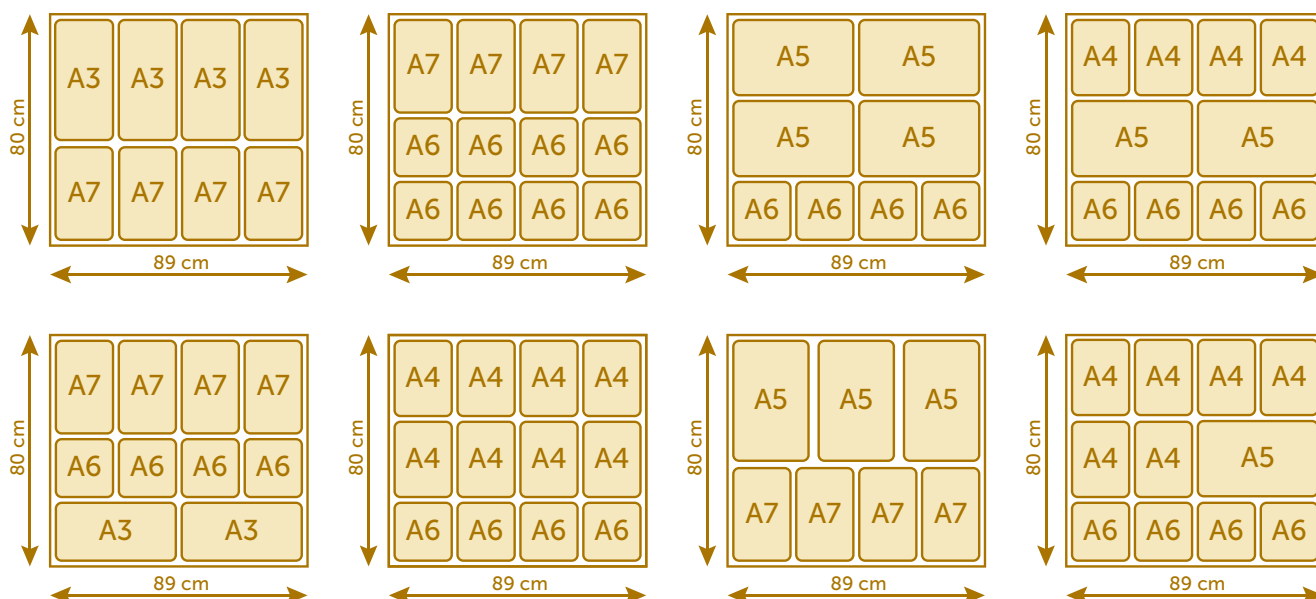



ACCESSORI DA CUCINA E LAVORAZIONE ALIMENTI

Kitchen accessories and food processing

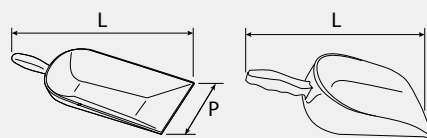

	L	P	l
31	43 cm	15 cm	-
136/19	19 cm	-	0,1
136/24	24 cm	-	0,2
136/29	29 cm	-	0,3
136/34	34 cm	-	0,6
136/38	38 cm	-	0,9
136/42	42 cm	-	1,5

SESSOLA RETTANGOLARE RECTANGULAR LARGE-SPOON



31
Sessola rettangolare
Rectangular large-spoon



136/19



136/24



136/29



136/34



136/38

136
Sessola
Large-spoon



136/42



Sessole - Portaposate HORECA

Large-spoon - HORECA cutlery tray

Le linee morbide e senza spigoli vivi delle capienti vasche facilitano la presa delle posate e le operazioni di pulizia. Le dimensioni del PORTAPOSATE HORECA (53x32,5xh9,5 cm) rispettano le misure GASTRONORM 1/1.

The smooth lines without corners and the wide depth of the compartments make it easier to clean and help to remove the cutlery from it. The dimensions of the HORECA CUTLERY TRAY (53x32,5xh9,5 cm) are those required by the GASTRONORM 1/1.



Il COPERCHIO, grazie alle sue particolari concavità corrispondenti alle vasche del portaposate, permette la sovrapposibilità dei portaposate chiusi e può essere usato da basamento quando non svolge la sua funzione di copertura.

The LID, thanks to its particular concave compartments of the cutlery containers, can be piled up when they are closed, so that they can be used as a flat base whether they do not work as to close the cutlery tray.



Portaposate HORECA HORECA cutlery tray

Le lunette, incavate lateralmente nel bordino superiore, servono come invito alla presa e da fessura per il sollevamento del PORTAPOSATE nel caso che quest' ultimo sia incassato dentro ad una apertura da banco GASTRONORM.



The lunette, hollowed in the upper edge, work as handles and help the taking out of the cutlery tray. They are especially useful to remove the cutlery tray when it is set in an open glass of the food display.

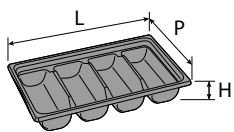

L 32,5 X P 53 X H 9,5 cm



86

Portaposate HORECA
HORECA cutlery tray

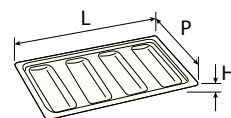

L 32,5 X P 53 X H 2 cm



86/1

Coperchio per portaposate HORECA
HORECA cutlery tray lid



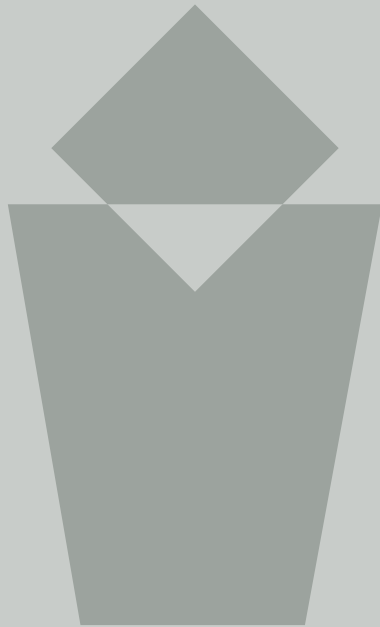

PULIZIA &

RACCOLTA DIFFERENZIATA

Cleaning & waste collection

pag. 44 art. 1/120/5

pag. 45 art. 1204 art. 1/120 art. 95/120 art. 1/120/5

pag. 46 art. 1/240/5

pag. 47 art. 2404 art. 1/240 art. 95/240 art. 1/240/5

pag. 48 art. 1/360/5

pag. 49 art. 6604 art. 1/660/5

pag. 50 art. 7704 art. 1/770/5

pag. 51 art. 1104 art. 1/1100/5

pag. 52 art. 95/1 art. 100

pag. 53 art. 95/1 art. 100 PUSH

pag. 54 art. 95/80 art. 80

pag. 55 art. 804 art. 105/25

pag. 56 art. 151 art. 95/80

pag. 57 art. 95/1 art. 91

pag. 58 art. 8 art. 77 art. 107/30

pag. 59 art. 8 art. 77 art. 90 art. 124/23

pag. 60 art. 95/1

pag. 61 art. 69/110

pag. 62 art. 100/4 art. 100/4 MIX

pag. 63 art. 26/35



PULIZIA & RACCOLTA DIFFERENZIATA

Cleaning &
waste collection



UNI EN 840
Certificato
Certified

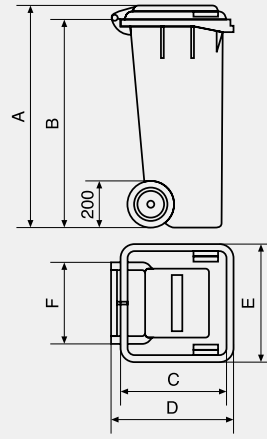

Carrellato	120 litri
A	930 mm
B	875 mm
C	485 mm
D	550 mm
E	480 mm
F	355 mm
G	480 mm
PESO / WEIGHT	9 Kg

BIDONE PER LA RACCOLTA DIFFERENZIATA

Disponibile in 8 colori, con ruote piene da Ø 200 mm
Prodotto in polietilene ad alta densità di prima scelta (HD-PE), resistente agli agenti chimici, non attaccabile dai parassiti, non assorbe i liquidi, è lavabile e sterilizzabile.
Livello di rumorosità < 97 db
Fornito smontato.

WASTE BIN

Available in 8 colours. It is supplied with wheels - Ø 200 mm
Made in high quality polyethylene (HD-PE), chemical agents and parasite resistant, liquid proof, washable and sterilizable.
Noise level < 97 db



1/120/5
120 litri

- BIANCO LATTE
(BIL)
- GIALLO (GIA)
- VERDE SCURO
(VES)
- VERDE BIDONE
(VEB)
- BRUNO BIDONE
(BRB)
- BLU BIDONE
(BLB)
- ROSSO BIDONE
(ROB)
- GRIGIO BIDONE
(GRB)



Bidoni carrellati e Bidoni carrellati bicolore

120 l

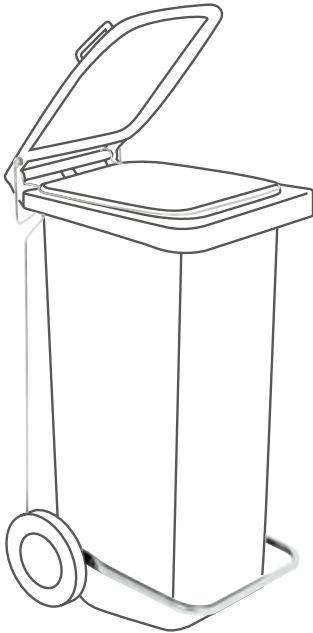

1204

Kit pedale + anello per bidone 120 l
120 l bin pedal and ring



1/120

Anello fermasacco per bidone 120 l
120 l bin ring

1/120

Anello fermasacco per bidone bicolore 120 l
120 l bin ring



95/120

Sacchetti immondizia per bidone
raccolta differenziata 120 l
120 l bin liners bags



1/120/5
120 litri

GRIGIO-GIALLO
(GRB-GIA)

GRIGIO-VERDE
(GRB-VES)

GRIGIO-BLU
(GRB-BLB)

GRIGIO-ROSSO
(GRB-ROB)





PULIZIA & RACCOLTA DIFFERENZIATA

Cleaning &
waste collection



UNI EN 840
Certificato
Certified

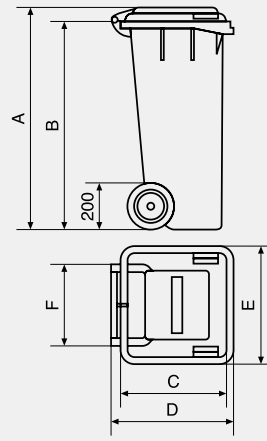

Carrellato	240 litri
A	1070 mm
B	995 mm
C	655 mm
D	730 mm
E	580 mm
F	420 mm
G	570 mm
PESO / WEIGHT	13 Kg

BIDONE PER LA RACCOLTA DIFFERENZIATA

Disponibile in 8 colori, con ruote piene da Ø 200 mm
Prodotto in polietilene ad alta densità di prima scelta (HD-PE), resistente agli agenti chimici, non attaccabile dai parassiti, non assorbe i liquidi, è lavabile e sterilizzabile.
Livello di rumorosità < 97 db
Fornito smontato.

WASTE BIN

Available in 8 colours. It is supplied with wheels - Ø 200 mm
Made in high quality polyethylene (HD-PE), chemical agents and parasite resistant, liquid proof, washable and sterilizable.
Noise level < 97 db



1/240/5
240 litri

BIANCO LATTE
(BIL)

GIALLO (GIA)

VERDE SCURO
(VES)

VERDE BIDONE
(VEB)

BRUNO BIDONE
(BRB)

BLU BIDONE
(BLB)

ROSSO BIDONE
(ROB)

GRIGIO BIDONE
(GRB)



Bidoni carrellati e Bidoni carrellati bicolore

240 l

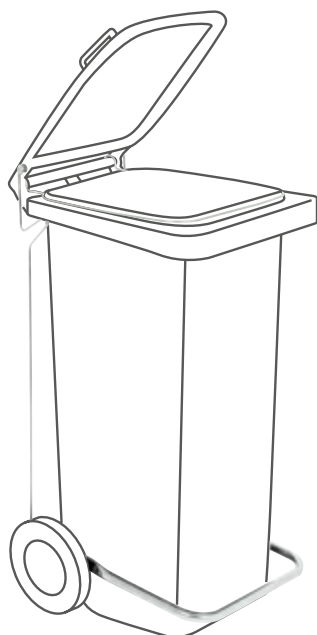

2404

Kit pedale + anello per bidone 240 l
240 l bin pedal and ring



1/240

Anello fermasacco per bidone 240 l
240 l bin ring

1/240

Anello fermasacco per bidone bicolore 240 l
240 l bin ring



95/ 240

Sacchetti immondizia per bidone
raccolta differenziata 240 l
240 l bin liners bags



CARTA



VETRO



PLASTICA



ORGANICO

1/240/5
240 litri



GRIGIO-GIALLO
(GRB-GIA)



GRIGIO-VERDE
(GRB-VES)



GRIGIO-BLU
(GRB-BLB)



GRIGIO-ROSSO
(GRB-ROB)





PULIZIA & RACCOLTA DIFFERENZIATA

Cleaning & waste collection

TÜV Rheinland[®]
UNI EN 840
Certificato
Certified

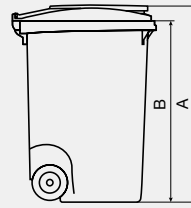
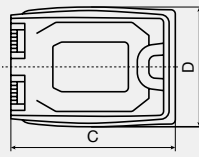

A	1099
B	1015
C	880
D	596
PESO / WEIGHT	15,5 Kg

Bidone carrellato 360 litri a due ruote per la raccolta differenziata. Prodotto realizzato in HDPE (polietilene alta densità) 100% riciclabile, stabilizzato UV per utilizzo in ambienti esterni. Capacità di carico max 160 kg Predisposto per presa frontale a pettine a norma DIN. Dotato di due ruote in gomma diametro 200 mm alloggiabili in due distinte posizioni per un'agile movimentazione e stabilità. Grande maneggevolezza, maniglie ergonomiche, bordi e spigoli arrotondati. Coperchio con apertura a libro e bordo anti infiltrazione, sede per alloggiamento microchip, elevata resistenza meccanica ed agli agenti chimici, facile da pulire e sanificare. Disponibile in 5 colori. Versione bicolore con bidone di colore grigio e coperchi in 4 colori differenti.

Two-wheeled 360 liter mobile waste bin for differential refuse collection Product made of 100% recyclable HDPE (high density polyethylene), UV stabilized for outdoor use. Max load capacity 160 kg. Prepared for DIN standard frontal socket. Equipped with two 200 mm diameter rubber wheels that can be housed in two distinct positions to move the bin in an easy way and have great stability. Easy handling, ergonomic handles, rounded corners and edges.

Lid with book opening and anti-infiltration edge, seat for microchip housing, high mechanical and chemical resistance, easy to clean and sanitize.

Available in 5 colors.

Bicolore available with grey body and lid in 4 different colors.



1/360/5
360 litri

GRIGIO BIDONE
(GRB)

GIALLO
(GIA)

VERDE BIDONE
(VEB)

ROSSO BIDONE
(ROB)

BLU BIDONE
(BLB)

GRIGIO-GIALLO
(GRB-GIA)

GRIGIO-ROSSO
(GRB-ROB)

GRIGIO-VERDE
(GRB-VEB)

GRIGIO-BLU
(GRB-BLB)



Cassonetti 4 ruote

660 l



6604

Kit pedale per cassonetto 660 l
660 l bin pedal

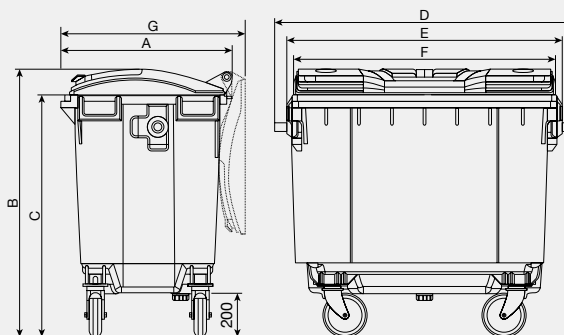

A	778
B	1228
C	1105
D	1370
E	1270
F	1200
G	836
PESO / WEIGHT	40 Kg

Cassonetto carrellato 4 ruote capacità 660 litri con coperchio piano.
Prodotto realizzato in HDPE (polietilene alta densità) 100% riciclabile stabilizzato UV per utilizzo in ambienti esterni.

Capacità di carico max 310 kg. Predisposto per presa frontale a pettine a norma DIN, dotato di quattro ruote girevoli (due delle quali con freno) con battistrada in gomma diametro 200. Grande maneggevolezza, assenza di bordi taglienti e spigoli smussati. Dotato di maniglie ergonomiche per la movimentazione, tappo sul fondo per una corretta pulizia e sanificazione.

Coperchio piano con apertura a libro ed impugnatura a labbro e bordo anti infiltrazione, sede per alloggiamento microchip.

Elevata resistenza meccanica ed agli agenti chimici.

Disponibile in 4 colori.

Disponibile versione bicolor con vasca di colore grigio e coperchi in 3 colori differenti.

Four-wheeled 660 liter mobile waste bin for differential refuse collection with flat lid. Product made of 100% recyclable HDPE (high density polyethylene), UV stabilized for outdoor use. Max load capacity 310 kg. Prepared for DIN standard frontal socket, equipped with four 200 mm diameter rubber caster wheels (two of them with braking system). Easy handling, ergonomic handles, rounded corners and edges. Equipped with ergonomic handles for handling, cap on the bottom for proper cleaning and sanitization. Flat lid with book opening and lip handle and anti-infiltration edge, seat for microchip housing. High mechanical and chemical resistance. Available in 4 colors.

Bicolor available with grey body and lid in 3 different colors.



1/660/5
660 litri

● GRIGIO BIDONE
(GRB)

● GIALLO
(GIA)

● VERDE BIDONE
(VEB)

● BLU BIDONE
(BLB)

●● GRIGIO-GIALLO
(GRB-GIA)

●● GRIGIO-VERDE
(GRB-VEB)

●● GRIGIO-BLU
(GRB-BLB)





Cassonetti 4 ruote

770 l

PULIZIA & RACCOLTA DIFFERENZIATA

Cleaning & waste collection

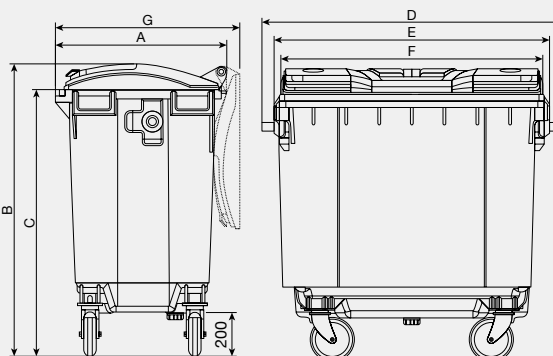

A	778
B	1365
C	1243
D	1370
E	1270
F	1200
G	836
PESO / WEIGHT	43 Kg

Cassonetto carrellato 4 ruote capacità 770 litri con coperchio piano.
 Prodotto realizzato in HDPE (polietilene alta densità) 100% riciclabile stabilizzato UV per utilizzo in ambienti esterni.
 Capacità di carico max 360 kg. Predisposto per presa frontale a pettine a norma DIN, dotato di quattro ruote girevoli (due delle quali con freno) con battistrada in gomma diametro 200. Grande maneggevolezza, assenza di bordi taglienti e spigoli smussati. Dotato di maniglie ergonomiche per la movimentazione, tappo sul fondo per una corretta pulizia e sanificazione. Coperchio piano con apertura a libro ed impugnatura a labbro e bordo anti infiltrazione. Elevata resistenza meccanica ed agli agenti chimici. Disponibile in 4 colori.
 Disponibile versione bicolor con vasca di colore grigio e coperchi in 3 colori differenti.

Four-wheeled 770 liter mobile waste bin for differential refuse collection with flat lid. Product made of 100% recyclable HDPE (high density polyethylene), UV stabilized for outdoor use. Max load capacity 360 kg. Prepared for DIN standard frontal socket, equipped with four 200 mm diameter rubber caster wheels (two of them with braking system). Easy handling, ergonomic handles, rounded corners and edges. Equipped with ergonomic handles for handling, cap on the bottom for proper cleaning and sanitization. Flat lid with book opening and lip handle and anti-infiltration edge, seat for microchip housing. High mechanical and chemical resistance. Available in 4 colors. Bicolor available with grey body and lid in 3 different colors.



7704

Kit pedale per cassonetto 660 l
660 l bin pedal



1/770/5
770 litri

● GRIGIO BIDONE (GRB)

● GIALLO (GIA)

● VERDE BIDONE (VEB)

● BLU BIDONE (BLB)

●● GRIGIO-GIALLO (GRB-GIA)

●● GRIGIO-VERDE (GRB-VEB)

●● GRIGIO-BLU (GRB-BLB)



Cassonetti 4 ruote

1100 l



1104

Kit pedale per cassonetto 660 l
660 l bin pedal

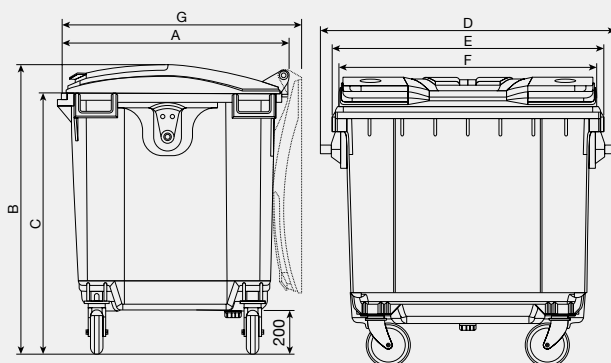

A	1070
B	1344
C	1280
D	1370
E	1270
F	1200
G	1127
PESO / WEIGHT	50 Kg

Cassonetto carrellato 4 ruote capacità 1100 litri con coperchio piano.
Prodotto realizzato in HDPE (polietilene alta densità) 100% riciclabile stabilizzato UV per utilizzo in ambienti esterni.

Capacità di carico max 510 kg. Predisposto per presa frontale a pettine a norma DIN, dotato di quattro ruote girevoli (due delle quali con freno) con battistrada in gomma diametro 200. Grande maneggevolezza, assenza di bordi taglienti e spigoli smussati.

Dotato di maniglie ergonomiche per la movimentazione, tappo sul fondo per una corretta pulizia e sanificazione.

Coperchio piano con apertura a libro ed impugnatura a labbro e bordo anti infiltrazione. Elevata resistenza meccanica ed agli agenti chimici.

Disponibile in 4 colori.

Disponibile versione bicolore con vasca di colore grigio e coperchi in 3 colori differenti.

Four-wheeled 1100 liter mobile waste bin for differential refuse collection with flat lid. Product made of 100% recyclable HDPE (high density polyethylene), UV stabilized for outdoor use. Max load capacity 510 kg. Prepared for DIN standard frontal socket, equipped with four 200 mm diameter rubber caster wheels (two of them with braking system). Easy handling, ergonomic handles, rounded corners and edges. Equipped with ergonomic handles for handling, cap on the bottom for proper cleaning and sanitization. Flat lid with book opening and lip handle and anti-infiltration edge, seat for microchip housing. High mechanical and chemical resistance. Available in 4 colors.

Bicolor available with grey body and lid in 3 different colors.



1/1100/5
1100 litri

● GRIGIO BIDONE
(GRB)

● GIALLO
(GIA)

● VERDE BIDONE
(VEB)

● BLU BIDONE
(BLB)

●● GRIGIO-GIALLO
(GRB-GIA)

●● GRIGIO-VERDE
(GRB-VEB)

●● GRIGIO-BLU
(GRB-BLB)



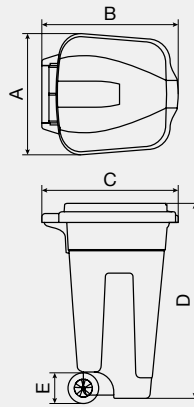

CENTO	100 litri
A	490 mm
B	540 mm
C	540 mm
D	850 mm
E	143 mm
PESO / WEIGHT	3,70 Kg

PULIZIA & RACCOLTA DIFFERENZIATA

Cleaning & waste collection

Bidoni per la raccolta differenziata da 100 l

particolarmente adatti per utilizzo interno in tutti gli ambienti. Disponibile in 4 colori (giallo, verde, rosso e blu) con base grigia.

Waste Bin 100 l

Wheelie bins suitable for internal use in all locations (offices, industries, communities...)

Available in 4 colors (yellow, green, red and blue) with grey base.



95/1

Sacchetti immondizia per bidone raccolta differenziata 100 l
100 l bin liners bags



Coperchi con chiusura a clip
Clip down lid



Maniglia ergonomica e rinforzata per facilitarne il trasporto
Ergonomic and thicker handle for an easy handling



Dotato di 4 ganci fermasacco
With 4 hooks keep bag



Bidone facilmente impilabile con ruote montate
Easy stackable bins with preassembled wheels



Alta scorrevolezza delle ruote antisdrucciolo ed estrema maneggevolezza nello spostamento
No-slip wheels and easy to manoeuvre

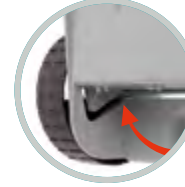

Ruote e assali premontati, meno errori e più facilità di spedizione con bloccaggio delle ruote per l'utilizzo finale
Wheels and axles already assembled, fast delivery and less problems. Wheels with brake for final use

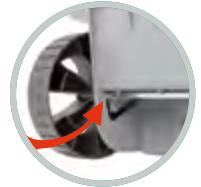

CENTO
100 litri



GRIGIO-GIALLO
(GRI-GIA)



GRIGIO-VERDE
(GRI-VES)



GRIGIO-BLU
(GRI-BLB)



GRIGIO-ROSSO
(GRI-ROB)



Bidone CENTO – CENTO PUSH

100 l

Bidoni per la raccolta differenziata da 100 l particolarmente adatti per utilizzo interno in tutti gli ambienti. Disponibile in 4 colori (giallo, verde, rosso e blu) con base grigia.

Waste Bin 100 l

Wheelie bins suitable for internal use in all locations (offices, industries, communities...)

Available in 4 colors (yellow, green, red and blue) with grey base.



95/1

Sacchetti immondizia per bidone raccolta differenziata 100 l
100 l bin liners bags

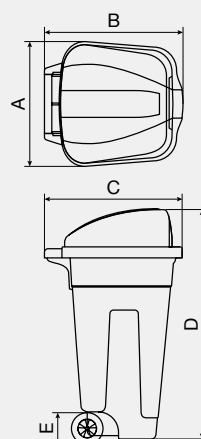

CENTO PUSH	100 litri
A	490 mm
B	540 mm
C	540 mm
D	950 mm
E	143 mm
PESO / WEIGHT	3,70 Kg



Maniglia ergonomica e rinforzata per facilitarne il trasporto

Ergonomic and thicker handle for an easy handling



Dotato di 4 ganci fermasacco
With 4 hooks keep bag



Campana basculante per bidone Cento Push
Flap lid for bin Cento Push



Bidone facilmente impilabile con ruote montate

Easy stackable bins with preassembled wheels



Alta scorrevolezza delle ruote antiscivolo ed estrema maneggevolezza nello spostamento

No-slip wheels and easy to manoeuvre

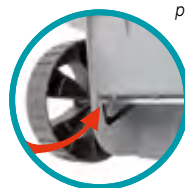
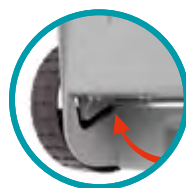

Ruote e assali premontati, meno errori e più facilità di spedizione con bloccaggio delle ruote per l'utilizzo finale
Wheels and axles already assembled, fast delivery and less problems. Wheels with brake for final use



CENTO PUSH
100 litri



GRIGIO-GIALLO
(GRI-GIA)



GRIGIO-VERDE
(GRI-VES)



GRIGIO-BLU
(GRI-BLB)



GRIGIO-ROSSO
(GRI-ROB)



PULIZIA & RACCOLTA DIFFERENZIATA

Cleaning & waste collection



95/80

Sacchetti immondizia per bidone raccolta differenziata 80 l bin liners bags



Coperchi con chiusura a clip
Clip down lid



Maniglia ergonomica e rinforzata per facilitarne il trasporto
Ergonomic and thicker handle for an easy handling



Dotato di 4 ganci fermasacco
With 4 hooks keep bag



Bidone facilmente impilabile con ruote montate
Easy stackable bins with preassembled wheels



Alta scorrevolezza delle ruote antisdrucciolo ed estrema maneggevolezza nello spostamento
No-slip wheels and easy to manoeuvre

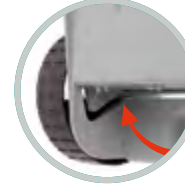

Ruote e assali premontati, meno errori e più facilità di spedizione con bloccaggio delle ruote per l'utilizzo finale
Wheels and axles already assembled, fast delivery and less problems. Wheels with brake for final use

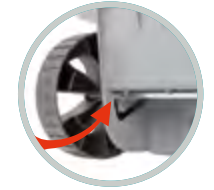

OTTANTA
80 litri



GRIGIO-GIALLO
(GRI-GIA)

GRIGIO-VERDE
(GRI-VES)

GRIGIO-BLU
(GRI-BLB)

GRIGIO-ROSSO
(GRI-ROB)

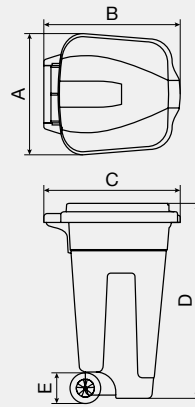
BIANCO
(BIL)



OTTANTA	80 litri
A	450 mm
B	500 mm
C	500 mm
D	780 mm
E	120 mm
PESO / WEIGHT	3 Kg

Bidoni per la raccolta differenziata da 80 l

particolarmente adatti per utilizzo interno in tutti gli ambienti. Disponibile in 4 colori (giallo, verde, rosso e blu) con base grigia, e una versione totalmente bianca per utilizzi specifici.

Waste Bin 80 l

Wheelie bins suitable for internal use in all locations (offices, industries, communities...)

Available in 4 colors (yellow, green, red and blue) with grey base and total white for specific use.

Bidone OTTANTA – DUSTY

80 l – 25 l

Pratico bidone portarifiuti da 25 litri,
con coperchio dotato di chiusura a clip.
Realizzato in polipropilene (PP) riciclabile 100%.
Design moderno, si adatta a tutti gli ambienti.
Disponibile con bidone di colore grigio e 4 varianti di
colore per il coperchio utili per la raccolta differenziata.

Practical 25 liter waste bin,
with lid equipped with clip closures.
Made of 100% recyclable polypropylene (PP).
Modern design, adapts to all environments.
Available with grey bin and 4 color variations for the lid useful for recycling.

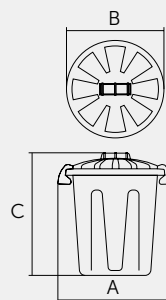

DUSTY	25 litri
A	400 mm
B	360 mm
C	450 mm
PESO / WEIGHT	0,95 Kg



Art. 804
Kit pedale optional
Optional pedal kit



105/25
25 litri

GRIGIO-GIALLO
(GRI-GIA)

GRIGIO-VERDE
(GRI-VES)

GRIGIO-BLU
(GRI-BLB)

GRIGIO-ROSSO
(GRI-ROB)





PULIZIA & RACCOLTA DIFFERENZIATA

Cleaning &
waste collection



Fornito in kit d'assemblaggio
Supplied in assembly kit



GRIGIO BIDONE
(GRN)

151
80 litri

BIANCO
(BIL)



95/ 80
Sacchetti immondizia per
bidone NELLO 80 l
Bin liners for NELLO 80 l



Apertura a pedale
Opening pedal

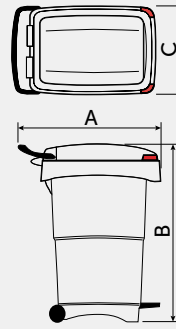

NELLO	80 litri
A	650 mm
B	810 mm
C	400 mm
PESO / WEIGHT	6,20 Kg

Nello è un bidone di nuova concezione che si distingue innanzitutto per il felice connubio estetico-funzionale evidenziato da linee morbide e ben raccordate tra loro.

Dotato di ruote e comoda maniglia per spostamenti veloci e sicuri, pedale di apertura e anello reggisacco.

Si adatta agli ambienti di lavoro professionale e hobbistico, come officine, garage, laboratori industriali.

151-GRN completo di n. 8 tappi in 4 colori per una corretta identificazione della differenziata.

Nello is a new-concept bin, which combines beauty and functionality stressed by an elegant and harmonic design.

Equipped with wheels and a handle for fast and safe movements, an opening pedal and bags holder ring.

It is suitable for internal use in all locations (workshops, garages, studios).

151-GRN includes a set of nr 8 cups in 4 different colours for a right waste separation and identification.

Bidone con coperchio

Bin with hinged lid

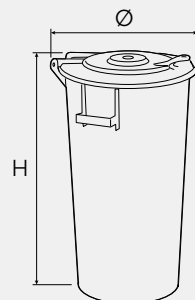

art. 91	Ø	H	capacità
91/060	Ø 45 cm	H 60 cm	l 60
91/080	Ø 45 cm	H 74 cm	l 80
91/100	Ø 45 cm	H 88 cm	l 100



95/ 1

Sacchetti immondizia
per bidone con cerniera.
Bin liners for hinged bin.



91/060
60 litri



91/080
80 litri



91/100
100 litri



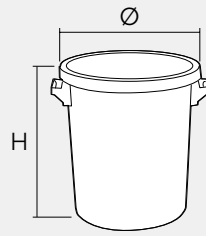

Bidoni industriali	litri	H	Ø
8/0035	35 l	41 cm	39 cm
8/0050	50 l	47 cm	46 cm
8/0075	75 l	57 cm	48 cm
8/0100	100 l	67 cm	52 cm
8/0150	150 l	71 cm	62 cm
8/0200	200 l	81 cm	67 cm

PULIZIA & RACCOLTA DIFFERENZIATA

Cleaning & waste collection



8/0035



PP 77/035



8/0050



PP 77/050



8/0075



PP 77/075



NERO (NER)



Cestino gettacarta

Waste-paper basket

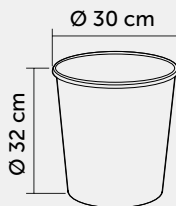

107/30



NERO (NER)



BRUNO RAME (BRR)



GRIGIO (GRI)



Bidoni industriali

Da 35 a 200 l

art. 77

Coperchi da l 35 a l 100 in PP
Coperchi da l 150 a l 200 in HDPE
Lids from 35 to 100 litres made of PP
Lids from 150 to 200 litres made of HDPE

art. 8

Bidone industriale.
Industrial bin.



8/0100



PP 77/100



8/0150



77/150



8/0200



77/200

Alzaimmondizia con manico

Standing dustpan

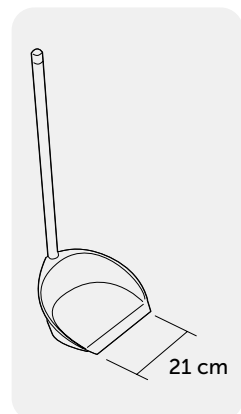

21 cm



90

BRUNO RAME
(BRR)



Paletta polvere

Dustpan



23 cm



124/23

BRUNO RAME
(BRR)





PULIZIA & RACCOLTA DIFFERENZIATA

Cleaning &
waste collection

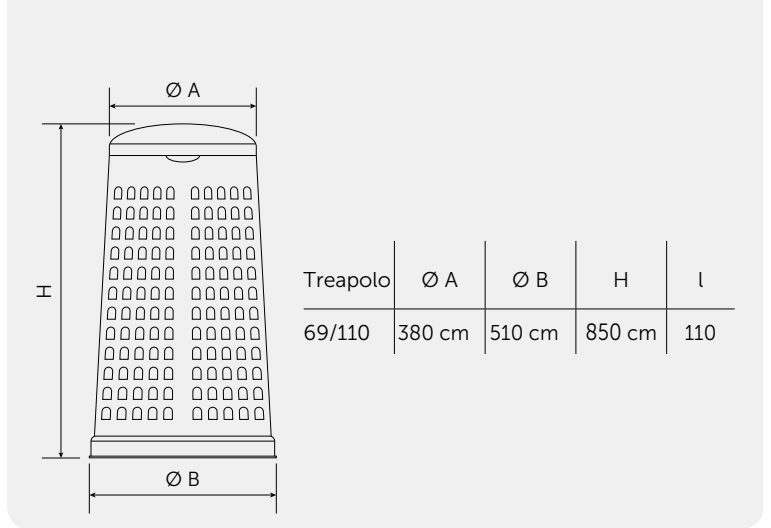

Trespolo leggero e facilmente sollevabile.
Pratico e semplice da utilizzare.
Lavabile e sterilizzabile.
Estremamente versatile per ogni tipo di rifiuto perchè prevede l'utilizzo del sacco raccogli immondizia, che viene fissato tramite l'anello ferma-sacco.
Ecologico, costruito in polietilene alta densità 100 % riciclabile.
Impilabile, occupa poco spazio in altezza.
È facilmente impilabile anche con il coperchio montato.

*Lightweight and easily liftable mesh waste bin.
Practical and easy to use.
Washable and sterilizable.
Suitable for each kind of waste, bag tie to ensure the bin bag stays secure.
Ecological, made of 100 % recyclable PEHD.
Stackable, it takes up little space in height.
Easily stackable also with preassembled lid.*



95/ 1
Sacchetti immondizia
per trespolo portasacco 110 l
110 l Bin liners for trestle.



GRIGIO
(GRB)



VERDE
(VES)



GRIGIO-GIALLO
(GRB-GIA)



GRIGIO-VERDE
(GRB-VES)



GRIGIO-BLU
(GRB-BLB)



GRIGIO-ROSSO
(GRB-ROB)



Possibilità di inserire loghi personalizzati
Customized logo available



69/110



PULIZIA & RACCOLTA DIFFERENZIATA

Cleaning &
waste collection



KIT 100/4-MIX
Ordinabile anche separatamente
To be ordered also separately

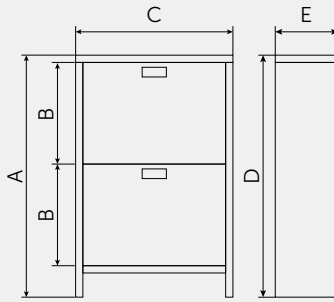

A	100 cm
B	43 cm
C	65 cm
D	100 cm
E	25 cm
PESO / WEIGHT	21 Kg

Mobiletto ventilato in lamiera elettrosaldata verniciato a forno in polvere epossidica

a due ribalte sovrapposte contenenti due secchi da 20 l ognuna.

A - Aerazione, ventilazione: il mobiletto è dotato di griglie di aerazione che hanno lo scopo di favorire la fermentazione dei residui organici e di smaltire l'odore sgradevole.

B - Robusti piedi, sollevato da terra per una agevole pulizia.

Cabinet in electro welded plate painted by epoxy powder oven.

with two superposed tilt drawers including two 20 l buckets each.

A - Airing/ ventilation: the cabinet is equipped with grates that help fermentation of the organic refusal and discharge the unpleasant odours.

B - Strong feet, lifted base to allow an easy cleaning.

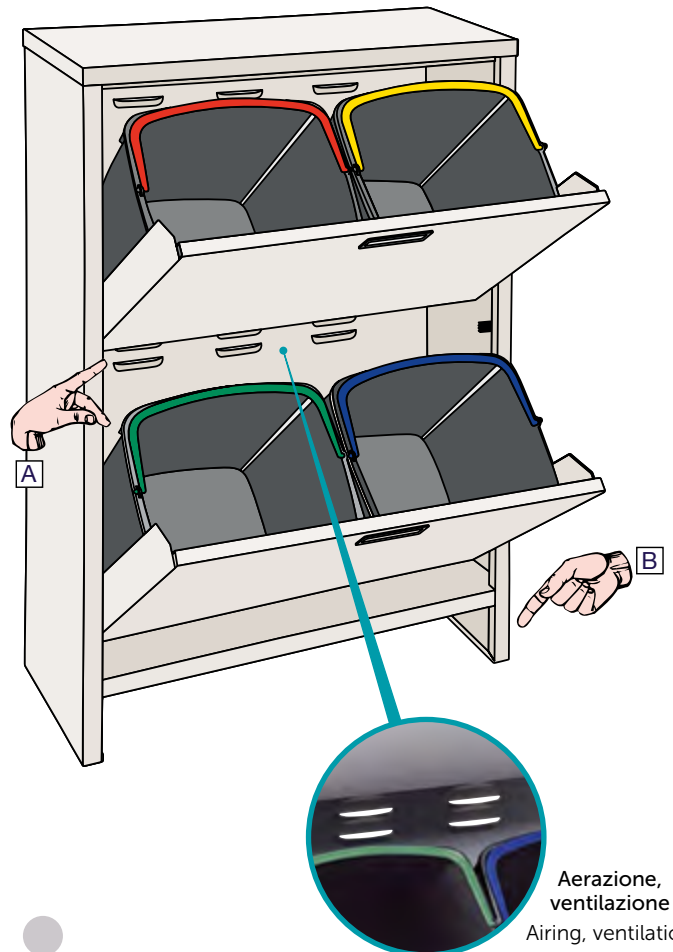

RAL 7035

ECO-AIR 4 – ECOTOP

ECOTOP: contenitori portarifiuti in PP riciclabile 100% con sportello a becco con apertura e chiusura basculante e antirandagismo

- Ideali per raccolta differenziata

Resistenti al gelo e al calore, agli agenti chimici, ai raggi UV e all'invecchiamento, prodotti con stabilizzanti anti-UV

Totale assenza di spigoli vivi con superfici esterne ed interne completamente lisce, impilabili e sovrapponibili

Presenza ergonomica sul fondo per facilitare lo svuotamento

Maniglia ergonomica e rinforzata con blocco in verticale

Coperchio con cerniere rinforzate e ribassate ad apertura 270°

ECOTOP: waste bins in 100% recyclable PP with tilt opening and closing and anti straylid coking

Perfect for separate collection

Resistant to freezing and heating, chemical agents, UV rays and aging because produced with anti-UV stabilizers

No sharp edges with smooth internal and external surfaces stackable

Ergonomic grip on the bottom for easy emptying

Ergonomic and reinforced handle with vertical locking

Reinforced hinges on the cover with opening at 270°



Eco-Top	L	H	P	litri
26/35	390 mm	425 mm	420 mm	35



26/35



GIALLO
(GIA)



VERDE SCURO
(VES)



BRUNO
(BRB)



BLU
(BLB)

Legenda / Legend



PRODOTTI IN MATERIALE
RICICLABILE



PRODOTTI IN MATERIALE
PER USO ALIMENTARE

TUTTI GLI ARTICOLI CONTRASSEGNA TI DAL SIMBOLO ALIMENTARE, SONO CONFORMI
ALLE DIRETTIVE CE n. 1935/2004, 2023/2006 E 10/2011
ALL ITEMS MARKED WITH THE FOOD USE LOGO, MEET EC REG.
n. 1935/2004, 2023/2006 AND 10/2011

MATERIALE / MATERIAL

- PP** : polipropilene / polypropylene
- HDPE** : polietilene ad alta densità / high density polyethylene
- LDPE** : polietilene a bassa densità / low density polyethylene
- ABS** : acrilonitrile-butadiene-stirene / acrylonitrile-butadiene-styrene
- SAN** : SAN (antiassorbente) / SAN (non-absorbing)
- PMMA** : PMMA metacrilato antiassorbente / PMMA non-absorbing methacrylate
- PC** : Policarbonato / Polycarbonate

COLORI / COLOURS

- | | |
|---|--|
| BIL : = bianco latte / milky white | GRI-BLB : = grigio-blu / grey-blue |
| BIM : = bianco / white | GRI-ROB : = grigio-rosso / grey-red |
| BLB : = blu bidone / bin blue | GRA : = grigio antracite / anthracite grey |
| BRB : = bruno bidone / bin brown | GRB : = grigio bidone / bin grey |
| BRR : = bruno rame / copper brown | GRI : = grigio / grey |
| GIA : = giallo / yellow | GRN : = grigio nero / black grey |
| GRB-GIA : = grigio-giallo / grey-yellow | N : = neutro / neutral |
| GRB-VEB : = grigio-verde chiaro / grey-light green | NER : = nero / black |
| GRB-VES : = grigio-verde / grey-green | ROB : = rosso bidone / bin-red |
| GRB-BLB : = grigio-blu / grey-blue | TS : = bianco trasparente / transparent white |
| GRB-ROB : = grigio-rosso / grey-red | VEB : = verde chiaro / light green |
| GRI-GIA : = grigio-giallo / grey-yellow | VES : = verde scuro / dark green |
| GRI-VEB : = grigio-verde / grey-green | |

Servizio clienti / Customer service



• MOBIL PLASTIC offre un completo servizio di informazioni attraverso il suo Ufficio Commerciale e Marketing. Un contatto diretto, per informazioni e richieste di cataloghi, si può avere anche attraverso la e-mail info@mobilplastic.it e l'accesso al sito Internet www.mobilplastic.it

• MOBIL PLASTIC offers a complete information service by means of the Sales and Marketing Department. You can contact the company directly for information and catalogues by e-mail info@mobilplastic.it and Internet Web site www.mobilplastic.it

servizio
clienti
Tel. 0039 0384 674692



servizio
clienti
Fax. 0039 0384 674696



e-mail
info@mobilplastic.it

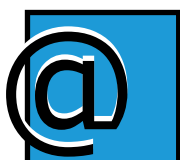

internet
www.mobilplastic.it



Informazioni / Inquiries

I colori riprodotti hanno valore indicativo.

The reproduced colours have an indicative value.

Le misure indicate hanno una tolleranza di ± 2 mm.

The above-cited dimensions have a tolerance of ± 2 mm.

I colori ed i modelli potranno subire variazioni senza preavviso.

Colours and models can be subject to change without warning.

È possibile fornire per quantità e prezzi da stabilire: prodotti in colori fuori catalogo; prodotti in materiale autoestinguente a norma UL 94; prodotti personalizzati.

It is possible to supply the following in individually arranged quantities and prices: Goods in colours not in catalogue; Goods in self extinguishing materials conforming to the norms UL 94; Personalized products.

Per impieghi diversi da quelli tradizionali si suggerisce di chiedere esplicite indicazioni.

For specific and different uses other than those listed it is suggested to contact the company directly.

Mobil Plastic®



www.mobilplastic.it



MOBIL PLASTIC S.P.A. - Via Robbio, 31 - 27030 CONFENZA (PV)
Tel. 0384.674692 (4 linee r. a.) - Fax: 0384.674696 - E-Mail: info@mobilplastic.it